

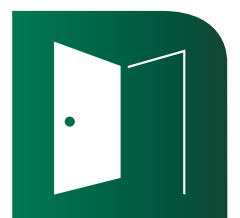

CUBICLES DESIGN 13

DURABLE
STRESSABLE · WATERPROOF





CONTENT

PRIVACY SOLUTIONS	4
PANEL MATERIAL	6
COLOUR RANGE	7
DESIGN 13 RP	8 - 9
DESIGN 13 RS	10 - 11
VERSIONS	12 - 13
QUALITY STANDARDS	14 - 15
ACCESSORIES	16 - 17
URINAL SCREENS	18 - 19
EXAMPLES	20 - 21
TECHNICAL DETAILS	22 - 23



PRIVACY SOLUTIONS

Products from meta

meta offers numerous solutions with multiple versions, to create your privacy.
We provide suitable solutions for all requirements.

We are the close and reliable partner to architects, planners, craftsmen and building authorities.



Quality

Our products meet your requirements.
Quality made in Germany.



Price/Service

We know that the price-performance relationship must be right and offer fair prices.



Innovation

We enjoy trying new things and are open-minded about changes.



Speed

We are fast. Your order can usually be produced within hours.



Delivery reliability

We don't let you down. We guarantee delivery on time.



Sustainability

We practice sustainable waste management and use environmentally friendly energy.



Technology

Our production works with the latest technology. This guarantees precision and a reliable high quality.



Assembly

Assembly is carried out by trained fitters. Customers may also choose self-installation with detailed installation manuals.



PANEL MATERIAL

Waterproof

13 mm HPL-Panels, which are highly scratch-resistant, low-wear and abrasion-resistant due to their special surface finish. Because of the solid core material, edges are not provided with an

edge banding, but are directly milled from the panel material. These cubicles are absolutely waterproof and a benchmark for stability and functionality.

RP FOR WET AREAS

- Made of 13 mm HPL-panels
- With rounded aluminium profiles
- Suitable for highest demands in wet areas

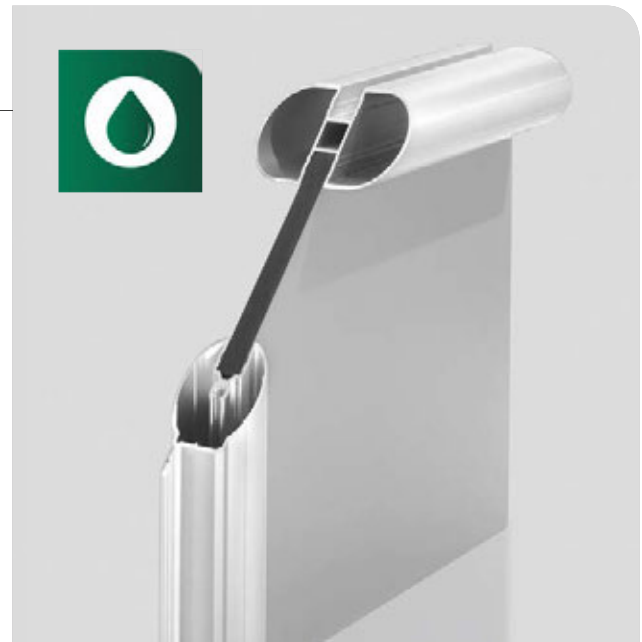

RS FOR WET AREAS

- Made of 13 mm HPL-panels
- With square aluminium profiles
- Suitable for highest demands in wet areas

COLOUR RANGE

PANELS STANDARD COLOURS

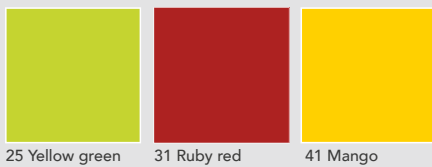

PANELS SPECIAL COLOURS with surcharge. Delivery time about 10 weeks.

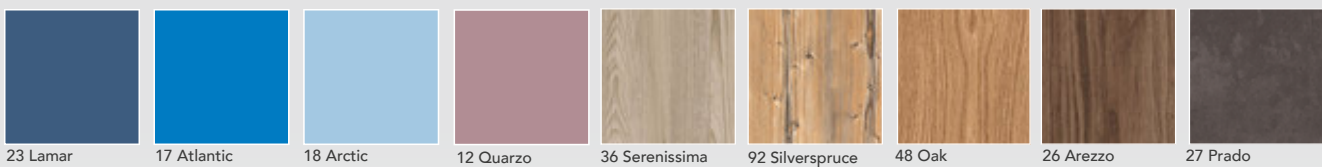
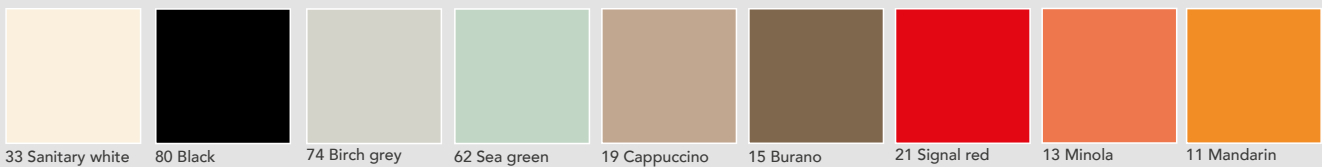

PROFILES AND ACCESSORIES STANDARD COLOURS

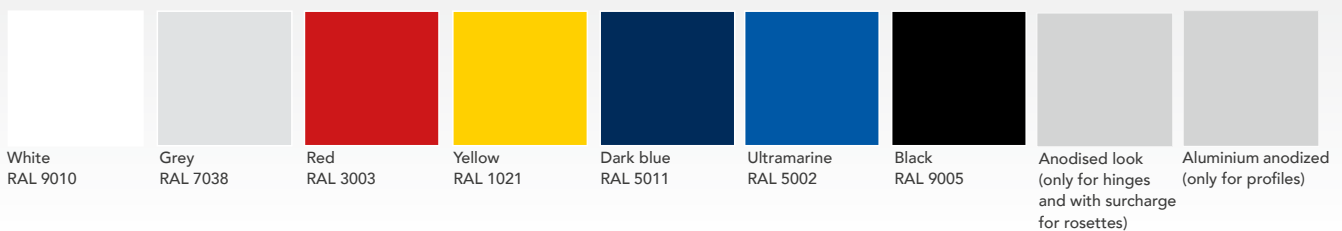

For technical reasons there might be a difference between RAL-colours and panel colours.

Due to technical printing reasons colours may differ from originals.

DESIGN RP

Wet area



WITH ROUNDED ALUMINIUM PROFILES



STANDARD VERSION

With support legs



Aluminium
cover profile

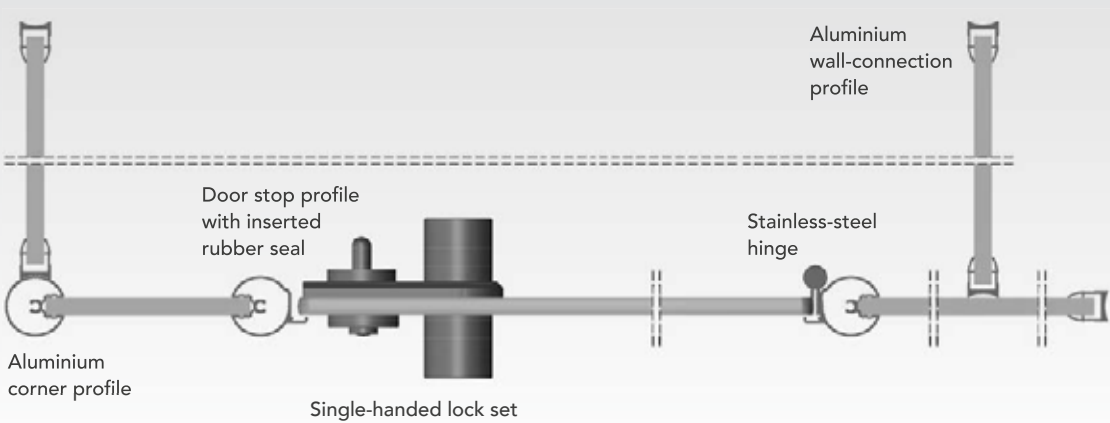
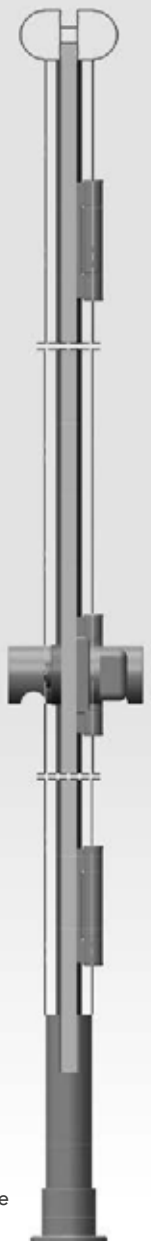

Aluminium tube
with height-adjustable
nylon rosette

DESIGN RS

Wet area



WITH SQUARE ALUMINIUM PROFILES



STANDARD VERSION

With support legs

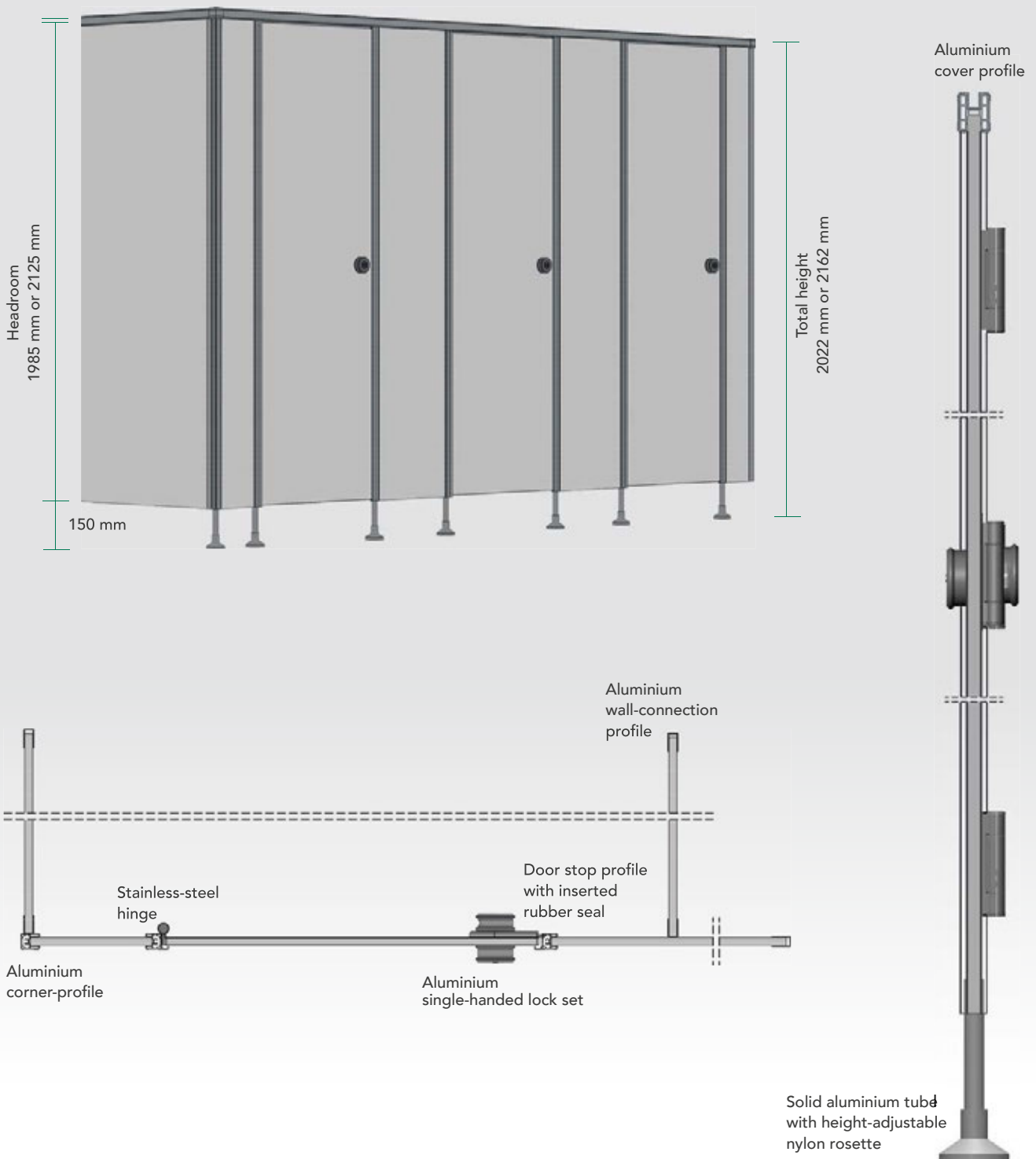

VERSIONS

Solutions for every requirement

We offer our cubicles in two heights according to DIN 18100 and DIN 18101. That way they fit perfectly into the room design and its door dimensions.

You can choose from several variants for floor and ceiling attachment to fully meet your individual requirements regarding design and function.

Examples Type 13 RP:

FLOATING

The support legs are placed 160 mm inwards from the front

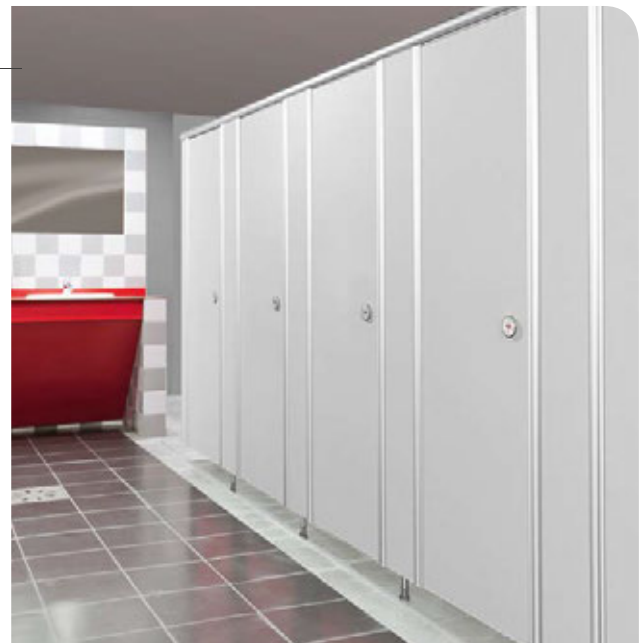

SUSPENDED

An aluminium supporting profile (height 160 mm) ensures a span up to approx. 5850 mm without support legs.





WITHOUT CLEARANCE

The cubicles are flush-mounted to the floor.



FULL-HEIGHT WITH PANELS

Panels are made of the same material as cubicles.

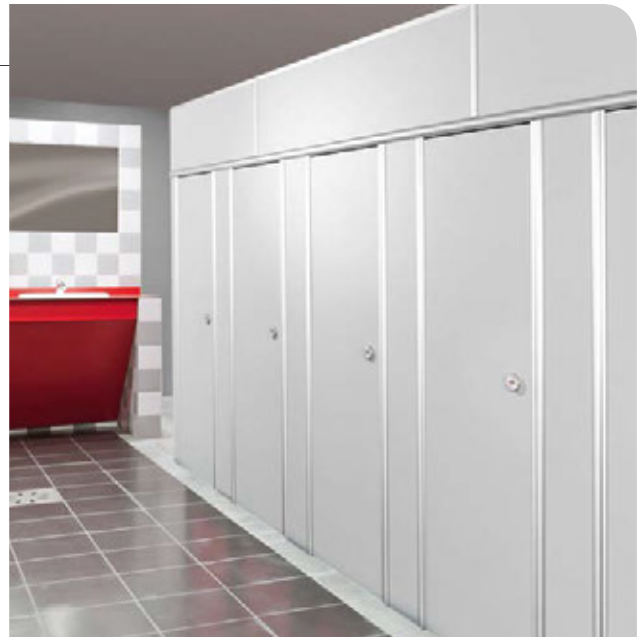
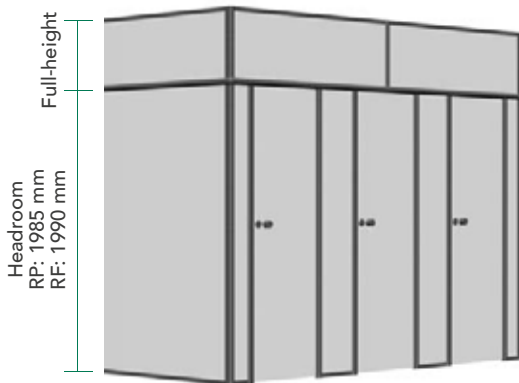

FULL-HEIGHT WITH GLASS

6 mm plexiglass transparent or ornamental.

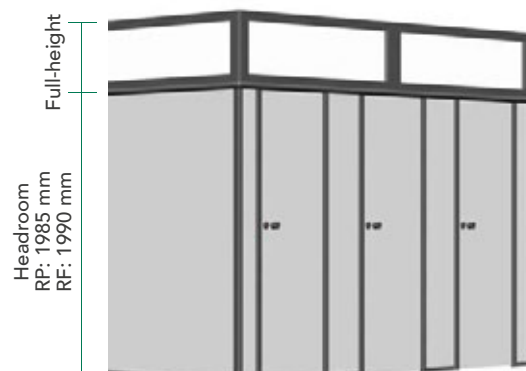

Examples 13 RP.
All versios also
possible as 13 RF.



HIGHLIGHTS WITHOUT EXTRA COST

- 3-roll stainless steel hinges with brass axle
- 12 panel colours
- 7 colours for nylon accessories
- 8 colours for aluminium profiles and stainless-steel hinges
- Short delivery times
- Inspected by the TÜV

„HIGH QUALITY“ IS OUR STANDARD

Perfect design

We pay great attention to stable, durable and vandalism-proof designs. Consequently, 3-roll stainless steel hinges are part of the standard design of each cubicle.

Also, high-quality aluminium profiles and nylon accessories in various colours are available at no extra cost. You can choose between 12 standard colours for panels.



3-roll stainless steel hinge



Powder coated aluminium lock case with nylon pull-knob ...



... and nylon red-white indicator



Nylon hook and buffer



Support leg 13 RP with height-adjustable nylon rosette



Support leg 13 RS with height-adjustable nylon rosette

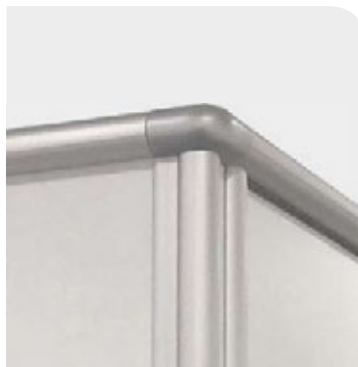

Corner connection 13 RP



Corner connection 13 RS

LOTS OF OPTIONAL EXTRAS

Nylon, aluminium & stainless steel

We offer a wide range of accessories: whether items of nylon which are optimally matched to our colour range, or sleek aluminium or high-quality stainless steel.

All items convince by quality, functionality and high-quality. This makes them a permanent part of our product range.

NYLON



Roll holder



Spare roll holder



WC-symbols

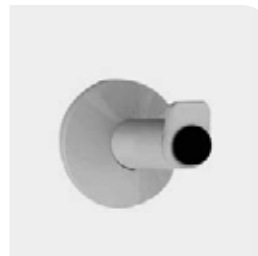

Hook with buffer



Toilet brush set

ALUMINIUM



Single-handed lock
RS4

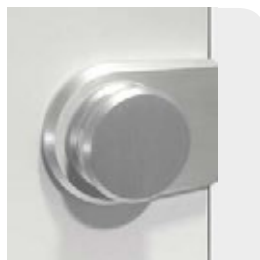

Inside



Roll holder



Spare roll holder



Toilet brush set

STAINLESS STEEL OR ALUMINIUM



Single-handed lock
RS2 Aluminium bolt lock
RS3 Stainless steel bolt lock



Hook

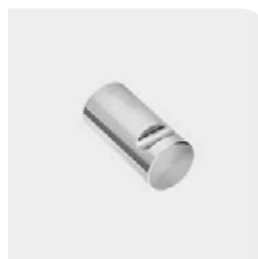

Buffer

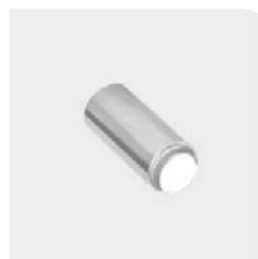

Hook with buffer

STAINLESS STEEL

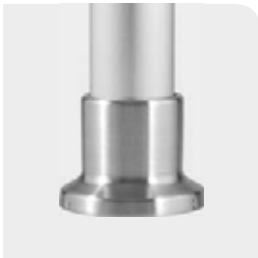

Rosette RP



Rosette RF



Stainless steel leg
floating versions

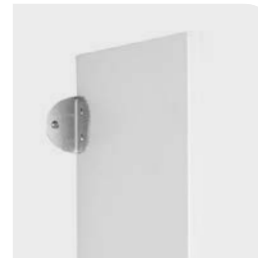

Support angle
urinal screen



Toilet brush set

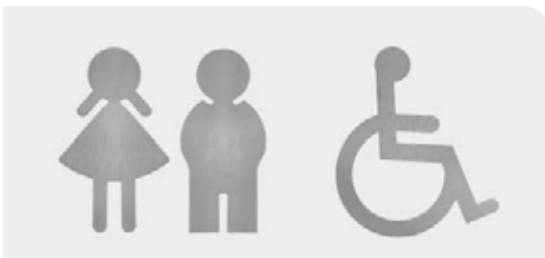

WC-symbols



Roll holder



Spare roll holder

CLAMP PROTECTION AT HINGE SIDE

Inner door 13 RS

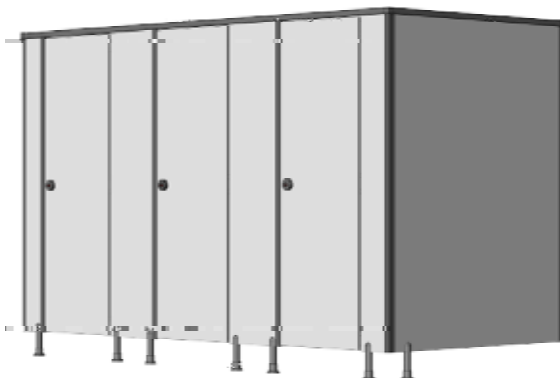

Outer door 13 RS

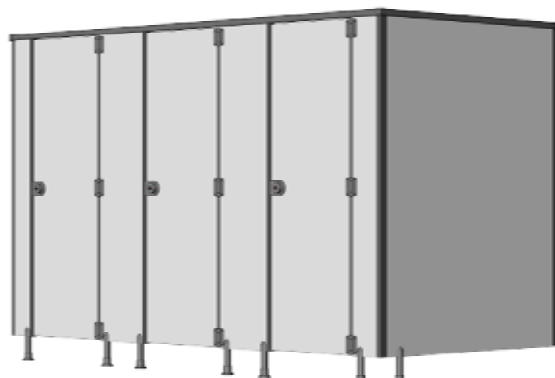

For technical reasons, systems with clamp protection require support feet around the door.

On doors that open outwards, the hinges, the lock case and the clamp protection profile are visible on the surface.



For 13 RP, this only applies to doors that open outwards.
For doors that open inwards, the standard feet are used.

URINAL SCREENS

Discretely divided

WALL MOUNTED

13 mm version:

Made of the same material as cubicle front.

Wall attachment with two powder coated support angles.

Glass version:

Consists of two pieces of glass with a glued-in matt foil. The surface therefore is smooth on both sides.

Wall attachment with four stainless steel support angles.

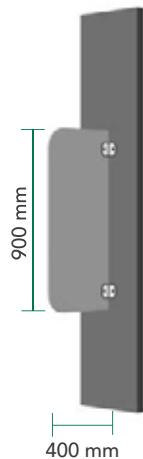

The front edges are rounded-off at a radius of 100 mm.



WITH SUPPORT LEG

Made of the same material as cubicle front.

Wall attachment with two powder coated support angles.

Floor-mounting with a support leg.

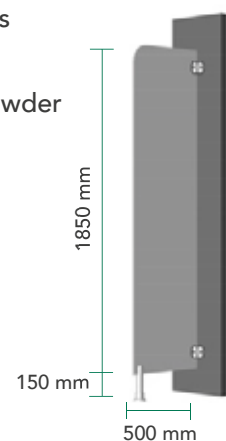



EXAMPLES

Our cubicles design rooms

We manufacture everything individually according to your requirements: from a simple WC-cubicle to designer installations. Let yourself be inspired!

Whichever version you choose – all our products are robust, durable and can be easily cleaned.

FLOATING

- Design 13 RP
- Aluminium anodized profiles
- Stainless steel single-handed locks
- Serenissima panels

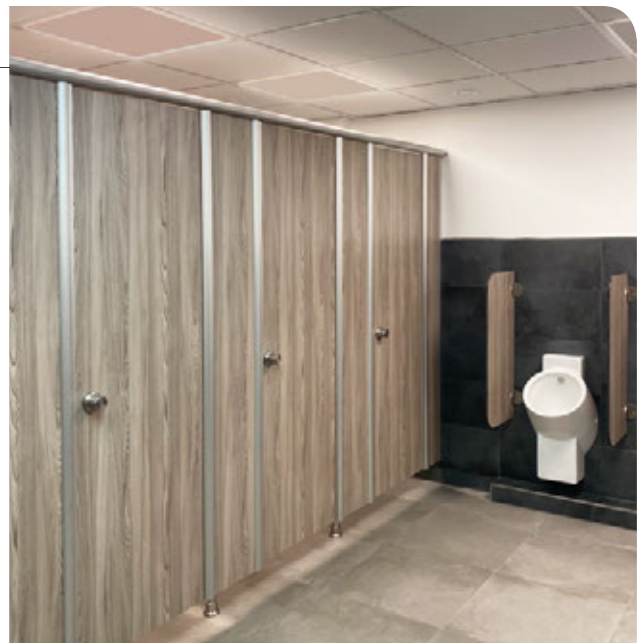

SUSPENDED

- Design 13 RP
- Aluminium anodized profiles
- Stainless steel single-handed locks
- Grey/ruby red panels



WITHOUT CLEARANCE

- Design 13 RP
- Grey profiles
- Nylon single-handed locks
- Grey and silverspruce panels

WITH SUPPORT LEGS

- Design 13 RP
- Aluminium anodized profiles
- Stainless-steel single-handed locks
- Graphite panels



WITH SUPPORT LEGS

- Design 13 RS
- Aluminium anodized profiles
- Aluminium single-handed locks
- Dark grey panels





TESTED BY GERMAN TÜV

Safety is our top priority

Our cubicles and lockers are inspected by TÜV and allow us to issue the GS mark for tested safety.

This ensures that our products meet the quality and safety standards of the German Product Safety Act.



TECHNICAL DETAILS

TECHNICAL DETAILS 13 RP STANDARD VERSION

Front walls

13 mm water resistant HPL-Panels with coarse matt surface on both sides. All visible edges milled and bevelled. An aluminium cover rail, 45 x 86 mm, which runs over the entire front, guarantees high stability. In the area of the wall connections, this is provided with aluminium cover caps to achieve a clean finish. Wall connections with rounded aluminium-U-profiles 22 x 30 mm.

Doors

Same material as front walls, self closing.
All edges rounded off in 20 mm radius, all corners in 9 mm radius. Door stop with rounded aluminium profile \varnothing 45 mm. Rubber seal on lock side for silent closing.

Partitions

Same material as front walls.
All visible edges milled and bevelled. Wall and front connections with rounded aluminium-U-profiles 22 x 30 mm.

TECHNICAL DETAILS 13 RS STANDARD VERSION

Front walls

13 mm water resistant HPL-Panels with coarse matt surface on both sides. All visible edges milled and bevelled. An aluminium cover rail, 37 x 29 mm, which runs over the entire front, guarantees high stability. Wall connections with square aluminium-U-profiles 17 x 30 mm.

Doors

Same material as front walls, self closing.
All visible edges milled and bevelled in 1 mm radius and all corners are rounded off in 3 mm radius. Square aluminium door stop profile 37 x 25,6 mm. Rubber seal on lock side for silent closing.

Partitions

Same material as front walls. All visible edges milled and bevelled.
Wall and front connections with square aluminium-U-profiles 17 x 30 mm.

ALL PRODUCT INFORMATION ONLINE

WWW.META.DE



www.meta.de



meta Trennwandanlagen GmbH & Co. KG

Metastraße 2 | 56579 Rengsdorf | Germany

Tel.: +49 2634 66-0 | Fax: +49 2634 66-450

info@meta.de

13-01-13

an **ABEO** company 